

The All-rounder series

MAGDOS DE/DX - Solenoid-Diaphragm Dosing Pumps 20,2 – 115 l/h, up to 10 bar



Reliable dosing of chemicals

Solenoid-diaphragm dosing pumps play an important role in the reliable and accurate dosing of liquids in process sequences. They are appropriate for low-pressure applications and small dosing quantities.

Dosing pumps are used in many branches of industry that work with liquid chemicals - not excluding toxic and aggressive media.

Flexible in the external actuation

The MAGDOS DE and DX unite modern micro-processing technology with high quality mechanics. Because of their versatility they offer the maximum amount of flexibility in their external control and are still simple to handle and easy to operate. Double-ball valves ensure highest accuracy even at smallest flow rates.

The MAGDOS DE and DX are available for many applications as they are equipped with high capacity lifting solenoids and the flow rate can be directly adjusted per stroke. The control of any contacts of commercial water meters is possible for proportional dosing.

Functions

- Suitable for toxic and aggressive media
- Stroke length adjustable 0 – 100%
- Stroke frequency adjustable
DE/DX 20 – 100: 0 – 70 /min.
- Switchable to external control (e.g. water meter)
DE/DX 20 – 100: up to 70 pulse/min.
- DX only Pulse multiplication/division 1, 2, 4, 8, 16, 32, 64, switchable to external control with 0/4 – 20 mA input
- Connection for level monitoring with early warning alarm
- Pulse and level control input electrically isolated
- Fault signalling relay and/or digital display (optional)
- Double-ball valves for highest accuracy
- All types are available for german standard DVGW-DIN 19635
- 15 V CSA proofed model

Technical specifications

MAGDOS DE/DX		20	40	100
Max. delivery pressure	bar	10	4	1.5
Delivery capacity at max. back pressure	l/h	20.2	50.4	115
Nominal stroke frequency	RPM	70		
Suction lift for non-gassing media	mWS	1.2		
Voltage supply		115 V or 230 V, $\pm 10\%$, 50/60 Hz		
Power consumption		230 V: 70 W, 115 V: 66 W		
Max. power consumption during dosing stroke		230 V: 4.1 A, 115 V: 7.4 A		
Protection class		IP65		
Insulation class		F		
Input pulse duration	ms	> 30		
Solenoid excitation time per pulse		230 V: 160 ms, 115 V: 190 ms		
Warning alarm relay with changeover contact (optional)		250 V 2,5 A, 30 V DC 2,5 A		
Voltage at level connection / pulse input		5 V DC, for potential-free switching outputs		
Load for 0/4 – 20 mA input	Ohm	150		
Weight	Plastic	kg	10.5	12.5
	Stainless steel (1.4571)	kg	12	20
Permitted ambient temperature	$^{\circ}\text{C}$	40		
Permitted media temperature	$^{\circ}\text{C}$	50 (with PVC parts 35)		

Delivery characteristic curves

These delivery capacities were determined on the manufacturer's test stands. They apply at 20 $^{\circ}\text{C}$ (68 $^{\circ}\text{F}$) for water, at 100 % stroke frequency. The delivery capacity depends on the medium (density and viscosity) and temperature. Since these conditions vary at every installation location, you should calibrate the dosing pump.

MAGDOS DE/DX 20

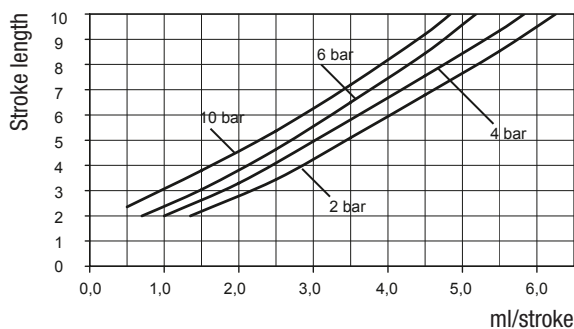

MAGDOS DE/DX 40

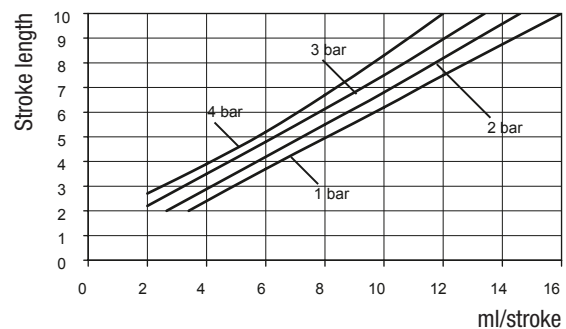

MAGDOS DE/DX 100

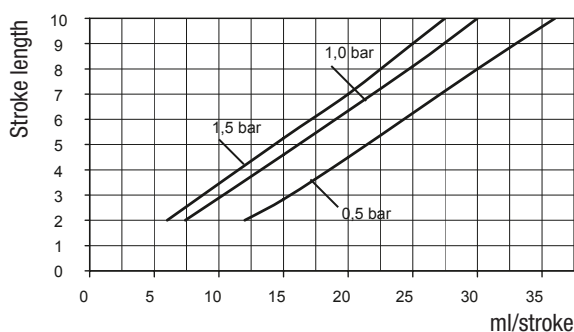

Dimensions

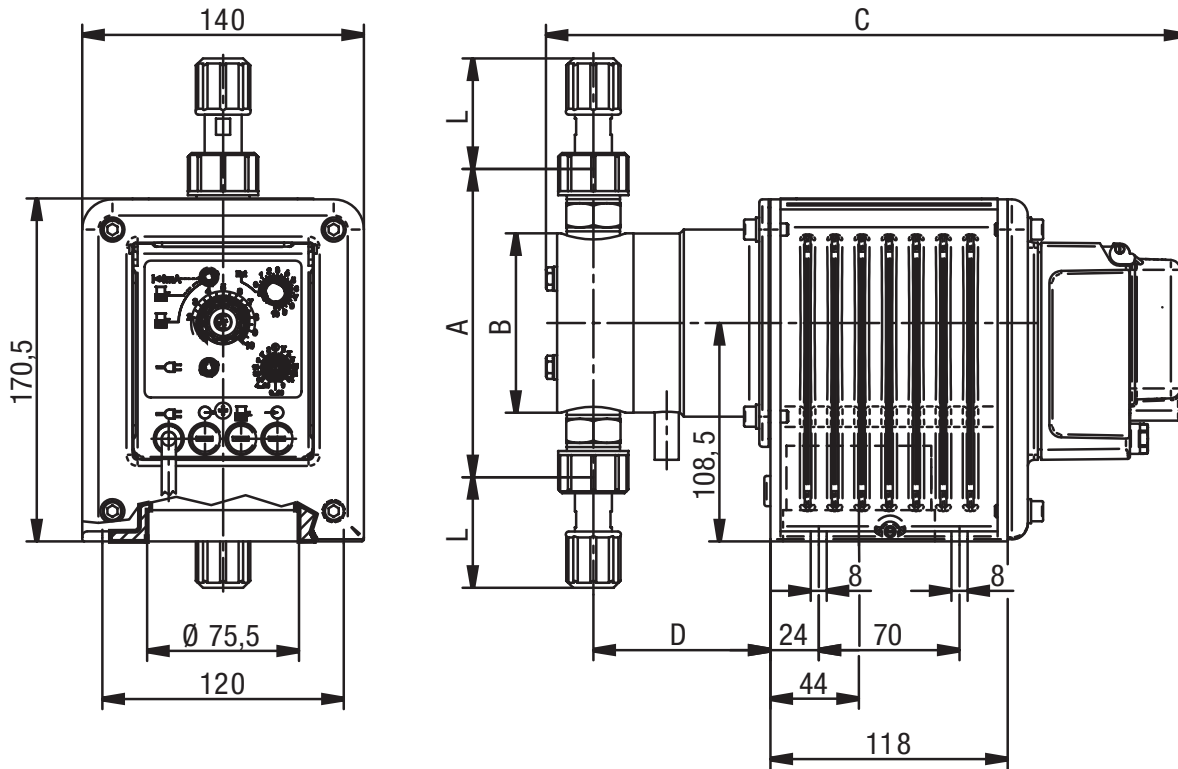

Type	Connection	Material	Scale	Nominal width	A	B	C	D	L
DE/DX 20	Hose clamp connection	PVC	6/12"	DN6	155	89	310	87	55
	Threaded connection	1.4571	G1/4	DN6	135	89	310	87	20
DE/DX 40	PVC cemented connection	PP	ø16	DN10	280	152	345	105	22
	Threaded connection	1.4571	G1/2	DN15	280	148	310	105	22
DE/DX 100	PVC cemented connection	PP	ø20	DN15	280	152	345	105	22
	Threaded connection	1.4571	G1/2	DN15	280	148	310	105	22

All dimensions in mm

You will receive further materials and connection possibilities for your dosing pump upon request.

MAGDOS DE/DX standard - accessories

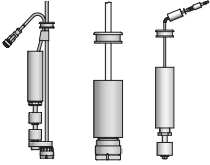

Suction lines and level control

Flexible suction line, type SL-2 with ceramic reinforcement piece, cable length 3,000 mm, tube length 2,500 mm. Level monitoring and pre-alarm with 2 switching points, switching distance approx. 50 mm. Switching function: Closer on rising level, electrical connection to dosing pump via plug connector M12x1.

Flexible suction line, SA model with foot valve and load part made from ceramic and 2,500 mm tube length. Flexible level control, with ceramic reinforcement piece, adjustable length.

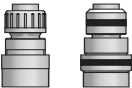

Foot valves

Non-return ball valve with suction filter, type FC with pipe glued connection.



Injection nozzles

To connect the dosing line to the dosing point.

Injection nozzle type R, spring loaded, opening pressure 0.1 bar



Suction and pressure tube

Permissible operating pressure at 20 °C in accordance with DIN EN ISO 7751, chemical resistance and correct connection are assumed.

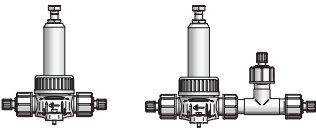

Back-pressure and pressure relief valves

Back-pressure valves to be mounted in the dosing line. Adjustable pressure 1 – 16 bar

Pressure-relief valves to be mounted in the dosing line. Adjustable pressure 1 – 16 bar



Stroke sensor HR

For the remote transmission of dosing strokes and for the actuation of further MAGDOS pumps. Cable length approx. 2.5 m



Leakage probe

Signaling of leakage in the case of diaphragm pumps via the conductivity of the medium.

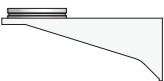

Wall bracket

Wall console with arbour. Material: Cast aluminium, varnished